

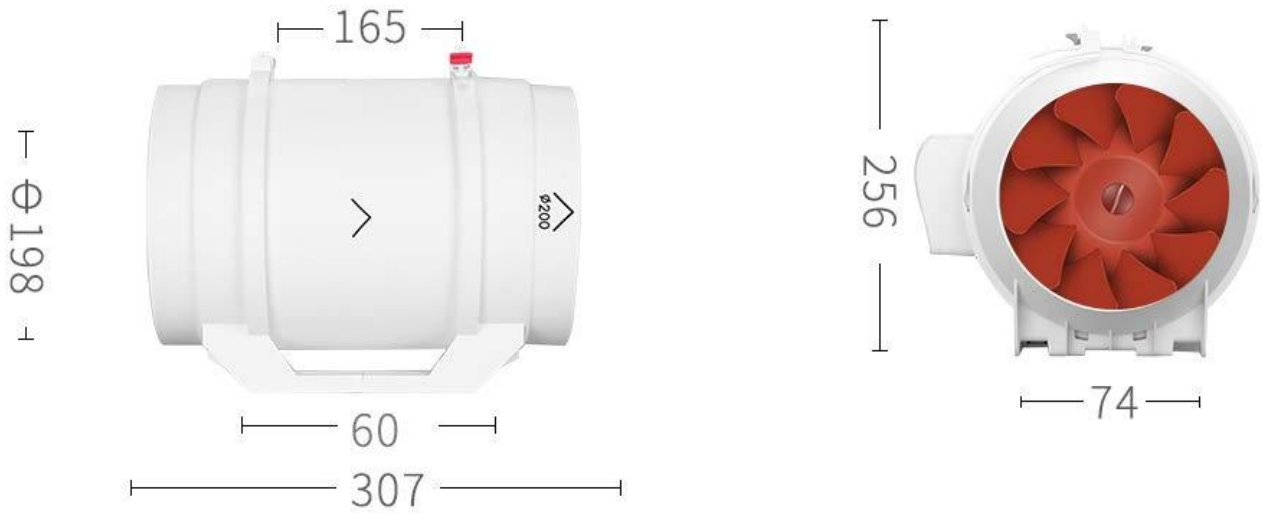

<b>Model</b> W200-01	<b>Working Voltage (V)</b> 110	<b>Frequency(Hz)</b> 60	<b>Power(W)</b> 101-131
<b>Rotationl Speed(r/min)</b> 1650-3000	<b>Air Volume(m<sup>3</sup>/h)</b> 572-850	<b>Air Pressure(Pa)</b> 167-370	<b>Noise(dB)</b> 55-63
<b>Cable Length (M)</b> 1.2	<b>Speed Level</b> 2	<b>Net Weight(KG)</b> 4.1	<b>Diameter(mm)</b> 200 (8 inch)

## DIMENSIONS (Unit: mm)



Simple dipping system allows quick removal of fan for maintenance



Mixed flow impeller design  
High air flow & pressure



Two-level speed control motor with lubricated ballbearings

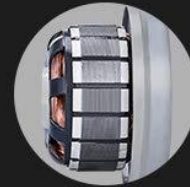

Japan NMB lubricated sealed bearings

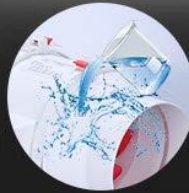

IPX4 waterproof, rain resistant for better motor protection



Corrosion resistant & Flameproof Plastic Material

Easy to install

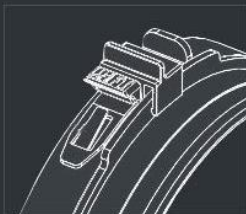

Unlock the mounting bracket & remove fan

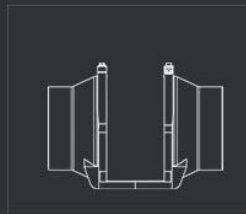

Mounting bracket with supplied screws

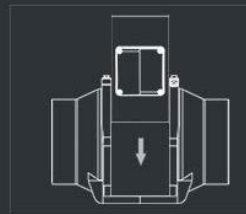

Install the ductwork on the mounting bracket assembly

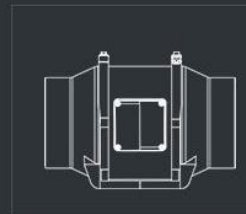

Replace the fan assembly and tighten the two flanges